

SIEMENS



www.siemens.com/medium-voltage-switchgear

Switchgear Type 8BT1, up to 24 kV, air-insulated

Medium Voltage Switchgear · Catalog HA 26.31 · 2012

Answers for infrastructure and cities.

Application	Page
Benefits	2
Typical uses	2 and 3
Technical Data	
Ratings	4
Classification, dimensions, room planning	5
Product Range	
Panels	6 and 7
Design	
Panel design	8
Compartments, interlocks, operation	9
Benefits and features	10
Standards	
Standards, specifications, guidelines, notes	11 and 12

Invalid: Catalog HA 26.31 · 2007

- Benefits** (see also page 10 for details)
- Saves lives
 - Peace of mind
 - Increases productivity
 - Saves money
 - Preserves the environment



Switchgear type 8BT1 is a factory-assembled, type-tested switchgear for indoor installation according to IEC 62 271-200 and VDE 0671-200.

8BT1 panel
Maximum ratings 24 kV / 25 kA / 2000 A

Typical uses
The 8BT1 switchgear can be used in transformer and switching substations, e.g.:

- Application: Power supply system**
- Power supply companies
 - Chemical industry
 - Petroleum industry
 - Pipeline installations
- Application: Industry**
- Power stations
 - Cement industry
 - Automobile industry
 - Iron and steel works
 - Rolling mills
 - Mining industry
 - Textile, paper and food industries
 - Electrochemical plants
 - Petrochemical plants
 - Diesel power plants
 - Emergency power supply installations
 - Lignite open-cast mines
 - Traction power supplies

ISO 9001
ISO 14001

DNV
Certified Company

OHSAS 18001

DNV
Certified Company

The products and systems described in this catalog are manufactured and sold according to a certified quality and environmental management system (acc. to ISO 9001 and ISO 14001).

Application

Typical uses

R-HA25-328.eps



Application
Industry

R-HA25-308.eps



Application
Public power
supply system

R-HA26-014.tif



8BT1 switchgear

R-HA25-327.eps



Application
Industry

Technical Data

Ratings

Electrical data (maximum values) of 8BT1

Ratings	Rated values (max.)
---------	---------------------

Switchgear 7.2 kV

Rated voltage	7.2 kV
Rated frequency	50 Hz
Rated short-duration power-frequency withstand voltage	20 kV
Rated lightning impulse withstand voltage	60 kV
Rated short-time withstand current, 3 s	25 kA
Rated peak withstand current at 50 Hz	63 kA
Rated short-circuit breaking current	25 kA
Rated short-circuit making current at 50 Hz	63 kA
Rated normal current of busbar	2000 A
Rated normal current of feeders	
– with circuit-breaker	2000 A
– with switch-disconnector	630 A
– with switch-disconnector with fuses	200 A ¹⁾

Switchgear 12 kV

Rated voltage	12 kV
Rated frequency	50 Hz
Rated short-duration power-frequency withstand voltage	28 kV
Rated lightning impulse withstand voltage	75 kV
Rated short-time withstand current, 3 s	25 kA
Rated peak withstand current at 50 Hz	63 kA
Rated short-circuit breaking current	25 kA
Rated short-circuit making current at 50 Hz	63 kA
Rated normal current of busbar	2000 A
Rated normal current of feeders	
– with circuit-breaker	2000 A
– with switch-disconnector	630 A
– with switch-disconnector with fuses	200 A ¹⁾

Ratings	Rated values (max.)
---------	---------------------

Switchgear 24 kV

Rated voltage	24 kV
Rated frequency	50 Hz
Rated short-duration power-frequency withstand voltage	50 kV
Rated lightning impulse withstand voltage	125 kV
Rated short-time withstand current, 3 s	25 kA
Rated peak withstand current at 50 Hz	63 kA
Rated short-circuit breaking current	25 kA
Rated short-circuit making current at 50 Hz	63 kA
Rated normal current of busbar	2000 A
Rated normal current of feeders	
– with circuit-breaker	2000 A
– with switch-disconnector	630 A
– with switch-disconnector with fuses	200 A ¹⁾

1) Depending on the rated current of the HV HRC fuses installed.

Classification of the 8BT1 switchgear acc. to IEC 62 271-200

Internal arc classification	
Classification	IAC
Accessibility	
– Front	Type A
– Rear	Type A
– Lateral	Type A
Test current	kA 25
Test duration	s 0.1/1.0

Construction and design	
Partition class for circuit-breaker	PM
Loss of service continuity category	LSC2A
Compartment accessibility (standard)	
– Busbar compartment	Tool-based
– Switching-device compartment	Interlock-based
– Connection compartment, front connection	Interlock-based

Dimensions

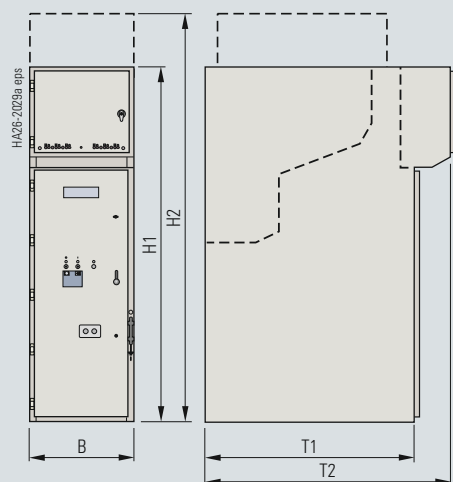

Room planning

(room height ≥ 2800 mm, ≥ 3000 mm ³⁾, ≥ 2400 mm ²⁾)

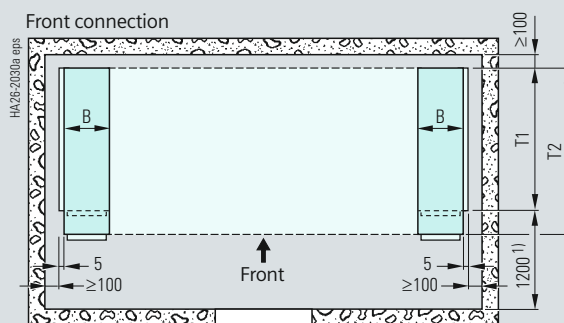

Single-row arrangement (plan view)

For dimensions B (width) and T (depth) refer to the table on this page

All panel types

7.2/12 kV

		Dimensions in mm
Width B	For max. 1250 A vacuum circuit-breaker	600
	For 2000 A vacuum circuit-breaker	800
	For switch-disconnector	600
Height H1	With standard low-voltage compartment	2050
	H2 With pressure relief system ³⁾	2300
	H2 With lead-off duct	2350
Depth T1	Without low-voltage compartment	1200
	T2 With low-voltage compartment	1410

24 kV

Width B	For max. 1250 A vacuum circuit-breaker	800
	For 2000 A vacuum circuit-breaker	1000
	For switch-disconnector	800
Height H1	With standard low-voltage compartment	2050
	H2 With pressure relief system ³⁾	2300
	H2 With lead-off duct	2350
Depth T1	Without low-voltage compartment	1200
	T2 With low-voltage compartment	1410

1) For panel replacement:
Control aisle ≥ 1600 mm

2) Lead-off duct required

3) For an arc fault duration of 1 s

Product Range

Panels

Circuit-breaker panel

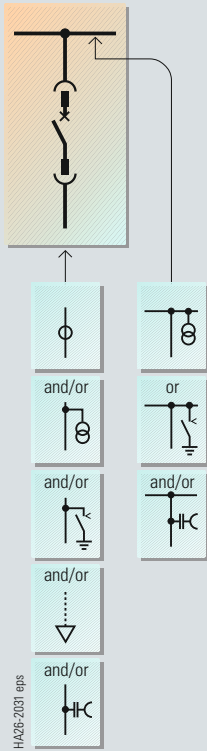

Disconnecting panel

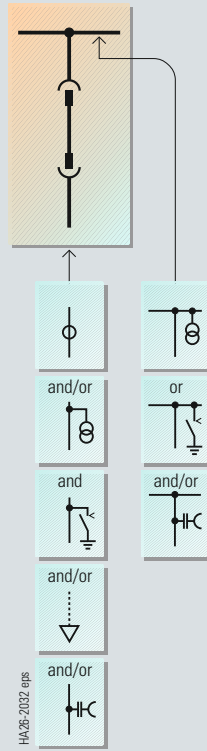

Switch-disconnector panel

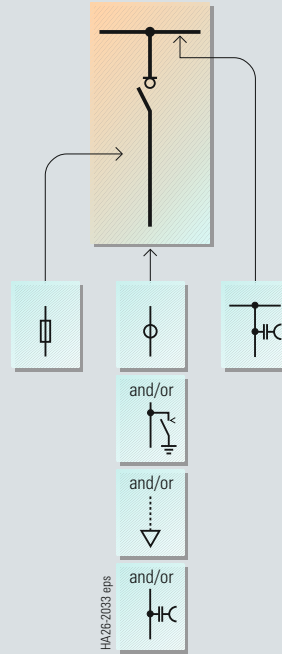

Components

	Current transformer
	Voltage transformer without primary fuses
	Capacitive voltage detection system

HA26-2034 eps

	Make-proof earthing switch
	Cable sealing ends ¹⁾ max. 4 x 500 mm ² per phase
	HV HRC fuse

	SION vacuum circuit-breaker
	Disconnecter
	Switch-disconnector

1) The details refer to conventional single-core sealing ends and are reduced by 1 cable when using surge arresters.

Bus sectionalizer I (mirror-image installation also possible)

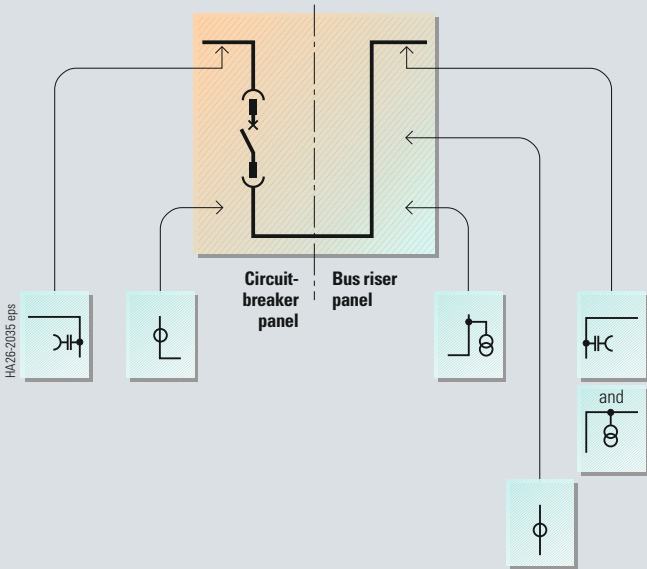

Metering panel

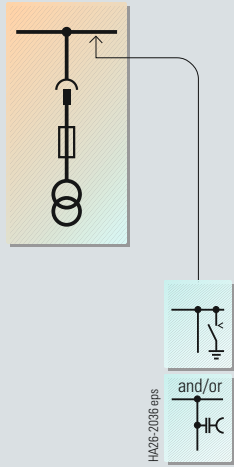

Busbar connection panel

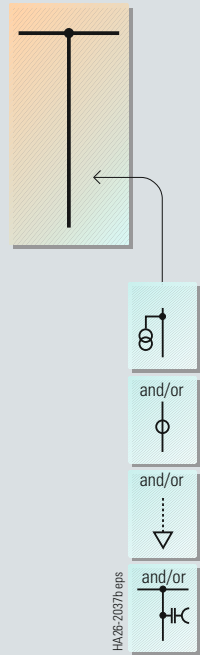

Bus sectionalizer II (mirror-image installation also possible)

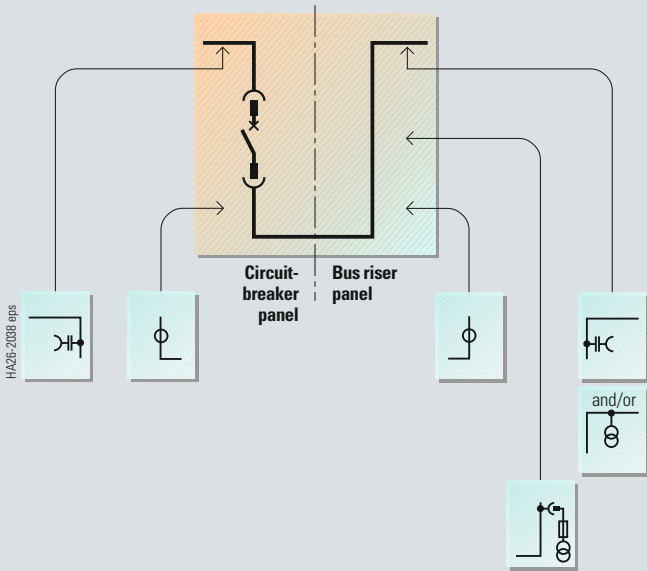

Components

	Current transformer
	Voltage transformer without primary fuses

HA26-2038a eps

	Capacitive voltage detection system
	Voltage transformer with primary fuses

	Make-proof earthing switch
	SION vacuum circuit-breaker
	Cable sealing ends ¹⁾ max. 4 x 500 mm ² per phase

1) The details refer to conventional single-core sealing ends and are reduced by 1 cable when using surge arresters.

Design

Panel design

Legend for panel design:

- 1 Door of low-voltage compartment
- 2 Opening for locking or unlocking the low-voltage compartment door
- 3 **Option:** Capacitive voltage detection system for feeder and busbar
- 4 High-voltage door of switching-device compartment
- 5 Inspection window for checking the disconnected/service position of the switching-device truck
- 6 Opening for locking or unlocking the high-voltage door
- 7 Actuating opening for the busbar earthing switch
- 8 Actuating opening for mechanical charging of circuit-breaker closing spring
- 9 Openings for manual operation (ON/OFF) of the circuit-breaker
- 10 Inspection window for checking the CLOSED/OPEN indication of the circuit-breaker, the "spring charged" indication and operating cycle counter
- 11 Knob for opening the door
- 12 Actuating opening for moving the switching-device truck
- 13 Actuating opening for the earthing switch
- 14 Busbars
- 15 Make-proof busbar earthing switch
- 16 Bushings
- 17 Busbar voltage transformer
- 18 Current transformer
- 19 Voltage transformer
- 20 Make-proof earthing switch
- 21 Cable sealing ends
- 22 Pressure relief
- 23 Low-voltage plug connector
- 24 Switching-device truck
- 25 Switch-disconnector
- 26 HV HRC fuse
- 27 Integrated partition
- 28 Operating mechanism for switch-disconnector
- 29 Operating mechanism for earthing switch
- 30 Actuating opening for the switch-disconnector
- 31 Inspection window for checking the switch-disconnector position, the earthing switch position and the "fuse tripped" indication

Basic panel design (example)

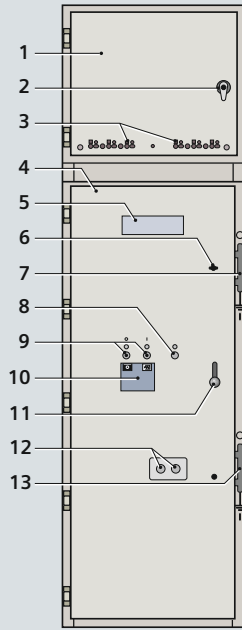

Circuit-breaker panel
12 kV, 1250 A

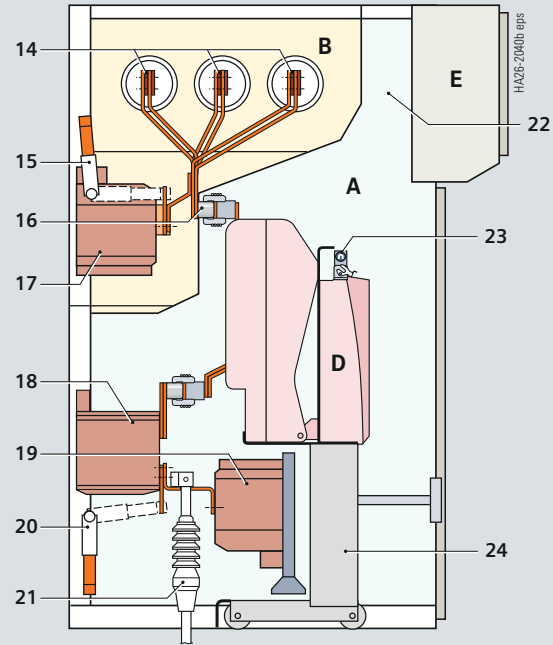

Design: Circuit-breaker panel

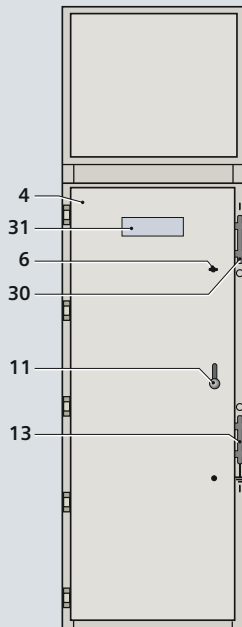

Switch-disconnector panel
12 kV, 1250 A

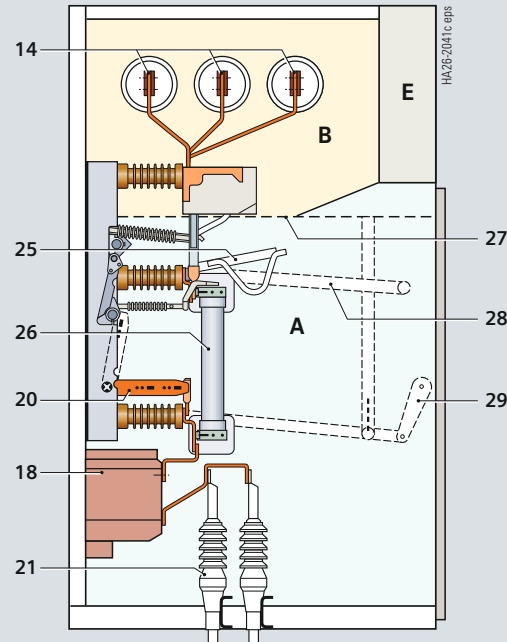

Design: Switch-disconnector panel

- A Combined switching-device/
connection compartment
- B Busbar compartment
- D Switching-device truck
- E Low-voltage compartment/
low-voltage niche

**Combined switching-device/
connection compartment**

- All switching operations with high-voltage door closed
- Pressure relief upwards
- Doors, front frames and end walls are powder-coated with epoxy resin. Rear wall and ceiling components are made of galvanized sheet metal
- Partition class:
Metallic, earthed shutters and partitions ensure partition class PM for circuit-breaker panel
- High-voltage door pressure-resistant in the event of internal arcs in the panel
- Metallic ducts on the side for laying control cables
- Interlocking between high-voltage door and circuit-breaker truck ensures interlock-based access
- Switching-device compartment to accommodate components for implementing various panel versions with
 - Vacuum circuit-breaker
 - Disconnecting truck
 - Metering truck
- Suitable for connection of
 - Single-core cables
 - Three-core cables
- Earthing busbar
- Connection from front interlock-based
- Option: Pressure-resistant floor cover
- Use of block-type current transformers
- Interlocked high-voltage door with connection from front provides interlock-based access

**Components at the panel
connection (option)**

- Single-core XLPE cables up to max. 4 x 500 mm² per phase
- Three-core XLPE cables up to max. 2 x 300 mm² per phase
- Coupling electrode for capacitive voltage detection system
- Voltage transformers
 - Cast-resin insulated
 - Max. 3 x 1-pole
 - Fixed-mounted, without primary fuses
- Make-proof earthing switches
 - With manual operating mechanism
 - In addition to standard interlocking of earthing switch/circuit-breaker truck, optionally lockable or with electromagnetic interlock
- Surge arresters
 - Surge arresters for protecting the switchgear against external overvoltages

Busbar compartment

- Pressure relief upwards
- Busbar transverse partition between panels
- Busbars made of flat copper, bolted from panel to panel
 - For rated normal currents up to 2000 A
- Bolted front covers provide tool-based access
- Option: Coupling electrode for capacitive voltage detection system
- Options: Possibility of installing the following components
 - Voltage transformers
 - Busbar earthing switch

Interlocks

- Interlocking conditions are satisfied according to IEC 62 271-200 / VDE 0671-200
- Earthing switch can only be operated with circuit-breaker truck in disconnected position
- Circuit-breaker truck can only be moved with circuit-breaker "OPEN" and earthing switch "OPEN"
- Circuit-breaker can only be operated in interlocked disconnected or service position
- Mechanical coding on the circuit-breaker truck prevents insertion of similar circuit-breaker trucks for lower rated normal currents into panels with higher rated normal currents
- Circuit-breaker truck can only be moved from disconnected to service position with door closed
- The high-voltage door can only be opened when the circuit-breaker truck is in disconnected position
- Option: Electromagnetic interlocks

Low-voltage compartment

- Accommodates equipment for protection, control, measuring and metering
- Separated from the high-voltage part of the panel, safe-to-touch
- Low-voltage compartment can be removed, bus wires and control cables are plugged in
- Option: Test sockets for capacitive voltage detection system

Low-voltage cables

- Control cables of the panel are flexible and have metallic covers
- Connection between switching-device truck and panel wiring to low-voltage compartment via 64-pole coded plug connectors
- Bus wires pluggable from panel to panel

Design

Benefits and features

Benefits	Features
<ul style="list-style-type: none">• Saves lives	<ul style="list-style-type: none">• All switching operations including emergency manual operations with high-voltage door closed• Interlocking between high-voltage door and switching devices• Rack-in, rack-out operations of the circuit-breaker truck with high-voltage door closed• Metallic, earthed shutters and partitions, partition class: PM for circuit-breaker panels• Internal arc classification up to 25 kA, 1 s, according to IEC 62 271-200, Annex A• Use of vacuum circuit-breakers
<ul style="list-style-type: none">• Peace of mind	<ul style="list-style-type: none">• Factory-assembled, type-tested switchgear according to IEC 62 271-200• Type testing of the circuit-breaker and make-proof earthing switch inside the panel• Use of standard, worldwide available components• Use of maintenance-free vacuum circuit-breakers• Quality management according to DIN EN ISO 9001• Design based on global best practice sharing and experience, compact design with high flexibility
<ul style="list-style-type: none">• Increases productivity	<ul style="list-style-type: none">• Use of metallic, earthed shutters and partitions ensures highest loss of service continuity category of the switchgear (LSC2A according to IEC 62 271-200) during maintenance• Use of maintenance-free vacuum circuit-breakers• Cable testing without isolating the busbar
<ul style="list-style-type: none">• Saves money	<ul style="list-style-type: none">• Use of maintenance-free vacuum circuit-breakers• Compact design requires minimum space
<ul style="list-style-type: none">• Preserves the environment	<ul style="list-style-type: none">• As insulating medium, air is absolutely neutral to the environment• Service life > 35 years optimizes the energy balance additionally• The materials used are fully recyclable without special knowledge



Standards

The switchgear complies with the relevant standards and specifications applicable at the time of type tests.

In accordance with the harmonization agreement reached by the countries of the European Community, their national specifications conform to the IEC standard.

Overview of standards (April 2012)

		IEC standard	VDE standard	EN standard
Switchgear	8BT1	IEC 62271-1	VDE 0671-1	EN 62271-1
		IEC 62271-200	VDE 0671-200	EN 62271-200
Devices	Circuit-breaker	IEC 62271-100	VDE 0671-100	EN 62271-100
	Disconnecter and earthing switch	IEC 62271-102	VDE 0671-102	EN 6 271-102
	Switch-disconnector	IEC 60265-1	VDE 0670-301	EN 60265-1
	Switch-disconnector / fuse combination	IEC 62271-105	VDE 0671-105	EN 62271-105
	HV HRC fuses	IEC 60282-1	VDE 0670-4	EN 60282-1
	Voltage detection systems	IEC 61243-5	VDE 0682-415	EN 61243-5
Degree of protection	–	IEC 60529	VDE 0470-1	EN 60529
Insulation	–	IEC 60071	VDE 0111	EN 60071
Transformers	Current transformers	IEC 60044-1	VDE 0414-1	EN 60044-1
	Voltage transformers	IEC 60044-2	VDE 0414-2	EN 60044-2
Installation	–	IEC 61936-1	VDE 0101	–

Type of service location

The switchgear can be used for indoor installation in accordance with IEC 61936 (Power installations exceeding 1 kV AC) and VDE 0101

- Outside lockable electrical service locations at places which are not accessible to the public. Enclosures of switchgear can only be removed with tools.
- Inside lockable electrical service locations. A lockable electrical service location is a place outdoors or indoors that is reserved exclusively for housing electrical equipment and which is kept under lock and key. Access is restricted to authorized personnel and persons who have been properly instructed in electrical engineering. Untrained or unskilled persons may only enter under the supervision of authorized personnel or properly instructed persons.

Table – Insulating capacity

Rated voltage (rms value)	kV	7.2	12	15	17.5	24
Rated short-duration power-frequency withstand voltage (rms value)						
– Across isolating distances	kV	23	32	39	45	60
– Between phases and to earth	kV	20	28	35	38	50
Rated lightning impulse withstand voltage (peak value)						
– Across isolating distances	kV	70	85	105	110	145
– Between phases and to earth	kV	60	75	95	95	125

Altitude correction factor K_a

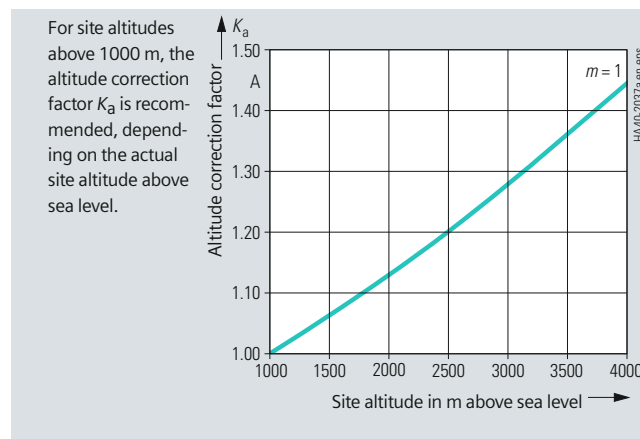

Rated short-dur. power-frequ. withstand volt. for site altitudes > 1000 m to be selected

≥ Rated short-duration power-frequency withstand voltage up to ≤ 1000 m · K_a

Rated lightning impulse withstand voltage for site altitudes > 1000 m to be selected

≥ Rated lightning impulse withstand voltage up to ≤ 1000 m · K_a

Example:

3000 m site altitude above sea level,
17.5 kV switchgear rated voltage
95 kV rated lightning impulse withstand voltage

Rated lightning impulse withstand voltage to be selected $95 \text{ kV} \cdot 1.28 = 122 \text{ kV}$

Result:

According to the above table, a switchgear for a rated voltage of 24 kV with a rated lightning impulse withstand voltage of 125 kV is to be selected.

Insulating capacity

• The insulating capacity is verified by testing the switchgear with rated values of short-duration power-frequency withstand voltage and lightning impulse withstand voltage according to IEC 62271-1/ VDE 0671-1 (see table “Insulating capacity”).

• The rated values are referred to sea level and to normal atmospheric conditions (1013 hPa, 20 °C, 11 g/m³ humidity in accordance with IEC 60071 and VDE 0111).

• The insulating capacity decreases with increasing altitude. For site altitudes above 1000 m (above sea level) the standards do not provide any guidelines for the insulation rating. Instead, special regulations apply to these altitudes.

• Site altitude

– As the altitude increases, the insulating capacity of insulation in air decreases due to the decreasing air density. This reduction is permitted up to a site altitude of 1000 m according to IEC and VDE.
– For site altitudes above 1000 m a higher insulation level must be selected. It results from the multiplication of the rated insulation level for 0 to 1000 m with the altitude correction factor K_a .

Standards

Standards, specifications, guidelines

Terms

“Make-proof earthing switches” are earthing switches with short-circuit making capacity according to

- IEC 62 271-102 and
- VDE 0671-102/
EN 62 271-102

Internal arc classification

- Safety of operating personnel ensured by tests to verify internal arc classification.
- Internal arc tests in accordance with IEC 62 271-200/ VDE 0671-200, Annex A.
- The switchgear complies with criteria 1 to 5 specified in the mentioned standards for the basic version up to 25 kA.
- Definitions of the criteria:
 - Acceptance criterion 1
Covers and doors remain closed. Limited deformations are accepted.
 - Acceptance criterion 2
No fragmentation of the enclosures. No projection of small parts above 60 g weight.
 - Acceptance criterion 3
No holes in the accessible sides up to a height of 2 m.
 - Acceptance criterion 4
Indicators do not ignite due to the effect of hot gases.
 - Acceptance criterion 5
The enclosure remains connected to its earthing parts.

Current-carrying capacity

- According to IEC 60 694/ VDE 0670-1000 and IEC 62 271-200/ VDE 0671-200 current-carrying capacities refer to the following ambient temperatures:
 - Maximum of
24-hour mean + 35 °C
 - Maximum + 40 °C
- The current-carrying capacity of the panels and busbars depends on the ambient temperature outside the enclosure.
- To attain the maximum rated normal currents, the panels are provided with natural or forced ventilation.

Climate and ambient conditions

The switchgear may be used, subject to possible additional measures, under the following ambient conditions and climate classes:

Ambient conditions

- Natural foreign materials
- Chemically active pollutants
- Small animals

Climate classes

- 3K3
- 3K5

The climate classes are classified according to IEC 60 721-3-3.

Protection against solid foreign bodies, electric shock and ingress of water

8BT1 switchgear fulfills acc. to the standards

- IEC 62 271-200/VDE 0671-200
- IEC 60 529/VDE 0470-1

the following degrees of protection:

- Enclosure: IP 4X
- Compartments: IP 2X

Notes

Published by and copyright © 2012:
Siemens AG
Wittelsbacherplatz 2
80333 Munich, Germany

Siemens AG
Infrastructure & Cities Sector
Low and Medium Voltage Division
Medium Voltage
Postfach 3240
91050 Erlangen, Germany
www.siemens.com/medium-voltage-switchgear

All rights reserved.
If not stated otherwise on the individual pages of this catalog, we reserve the right to include modifications, especially regarding the stated values, dimensions and weights.

Drawings are not binding.
All product designations used are trademarks or product names of Siemens AG or other suppliers.
If not stated otherwise, all dimensions in this catalog are given in mm.

Subject to change without prior notice.
The information in this document contains general descriptions of the technical options available, which may not apply in all cases. The required technical options should therefore be specified in the contract.

For more information, please contact our
Customer Support Center.
Phone: +49 180 524 70 00
Fax: +49 180 524 24 71
(Charges depending on provider)
E-Mail: support.ic@siemens.com

Order No. E50001-K1426-A301-A3-7600

Printed in Germany

Dispo 30400

KG 04.12 1.0 16 En

7400/42069 WÜ

Printed on elementary chlorine-free bleached paper.